

JN-4422

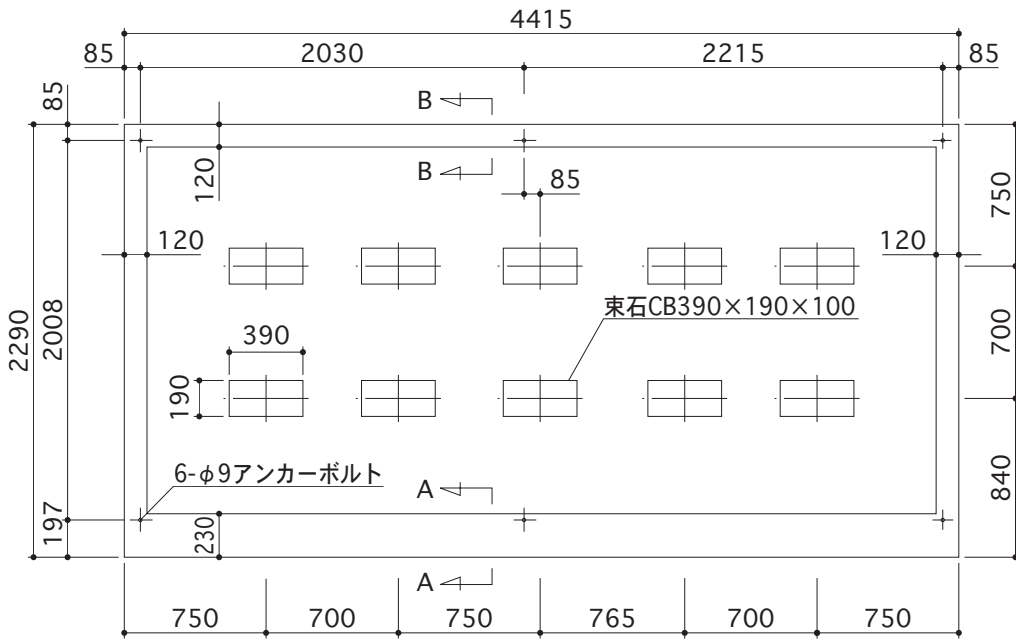

出入口側

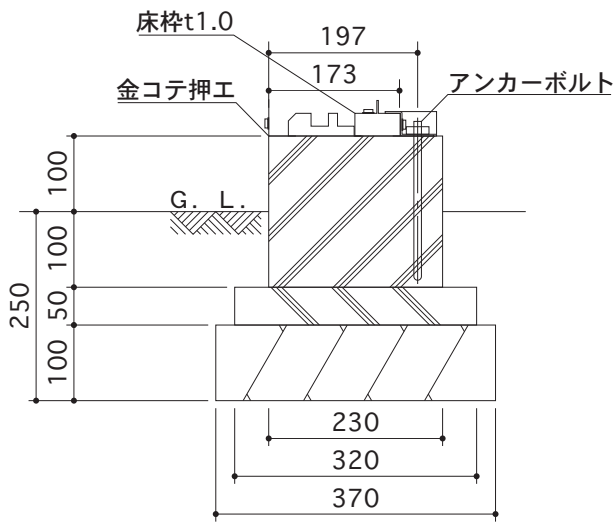

A-A断面図

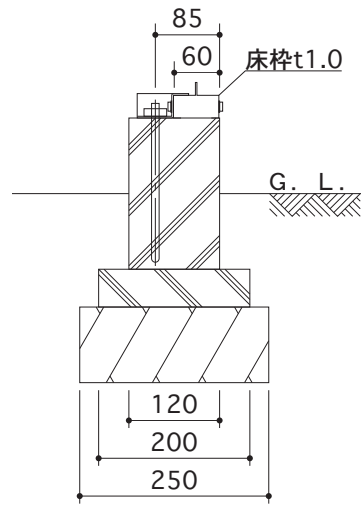

B-B断面図