

# TP-33R22(左物置)

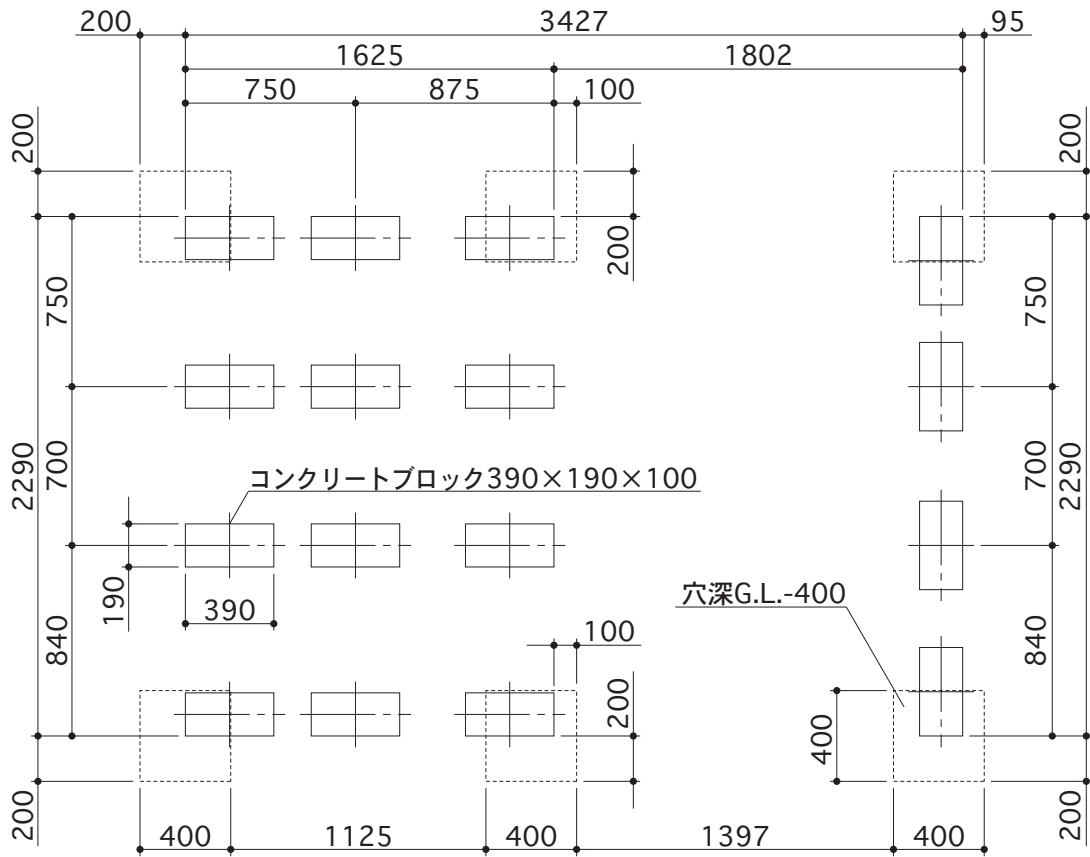

## 出入口側

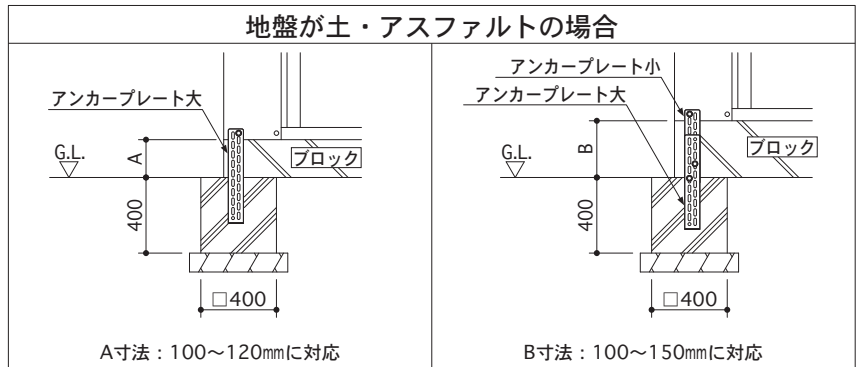
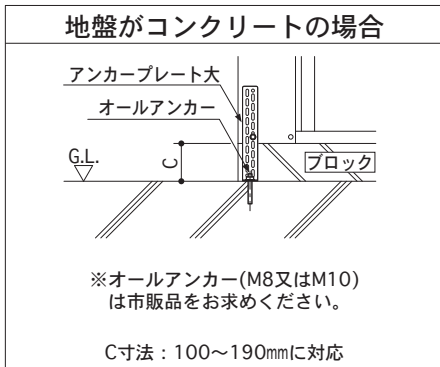

# TP-33R22(右物置)

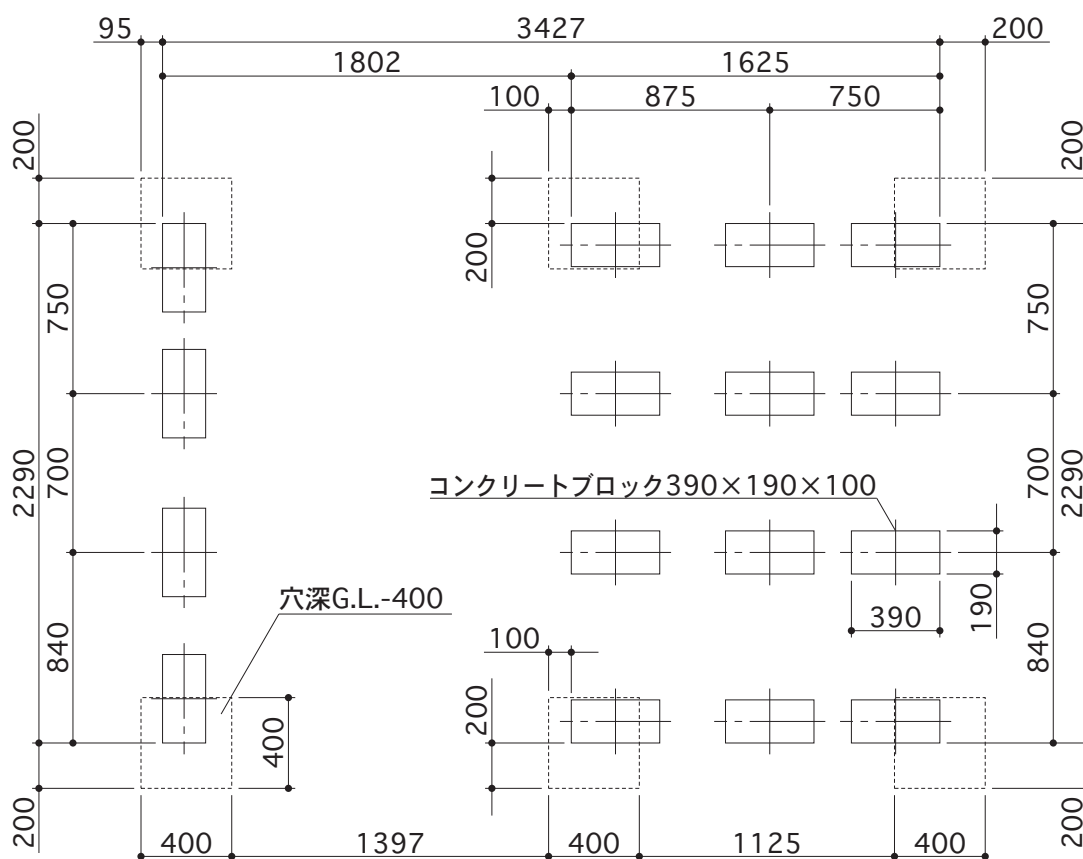

## 出入口側

