

# TP-33R19(左物置)

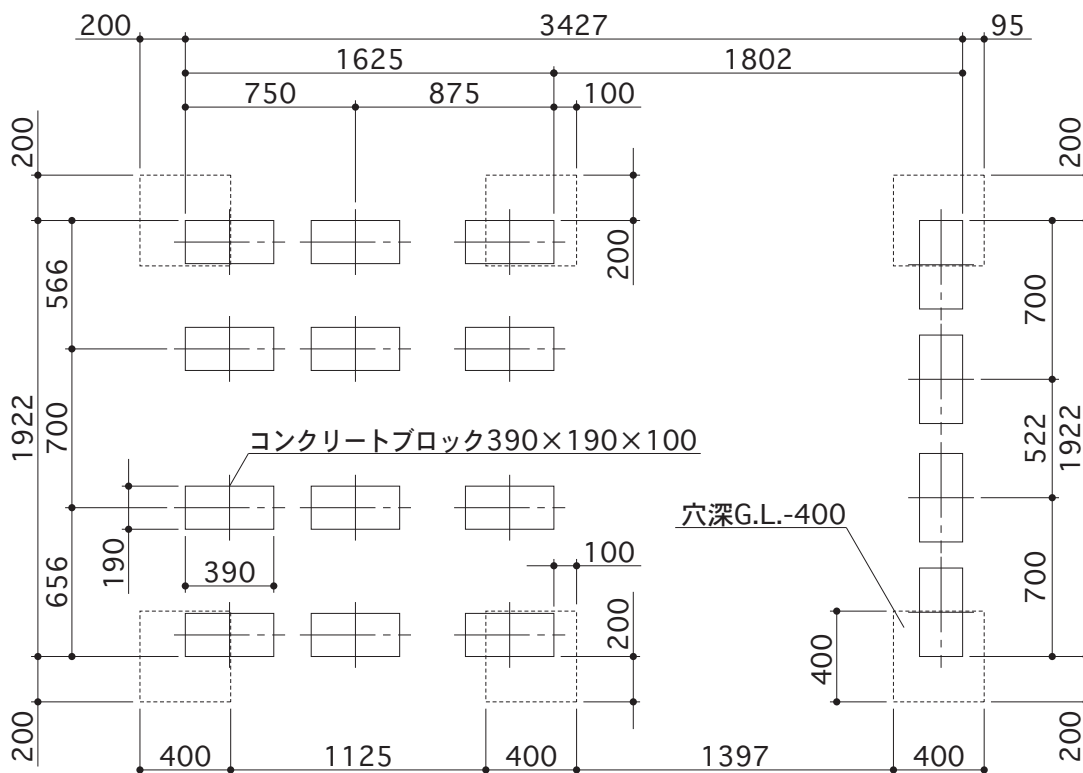

出入口側

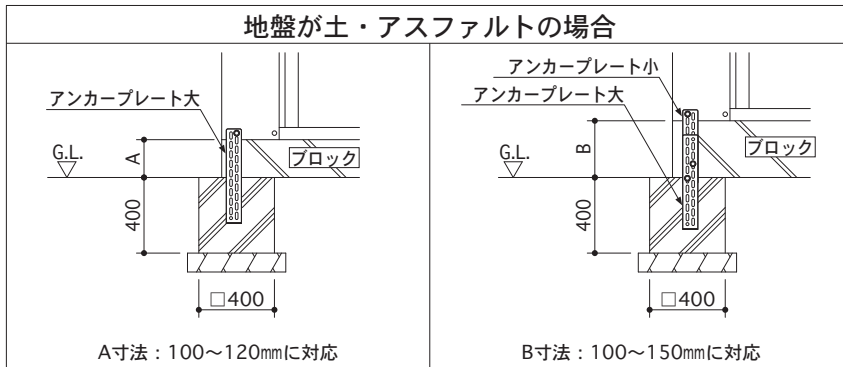
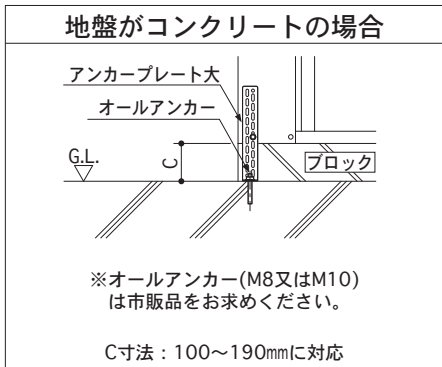

# TP-33R19(右物置)

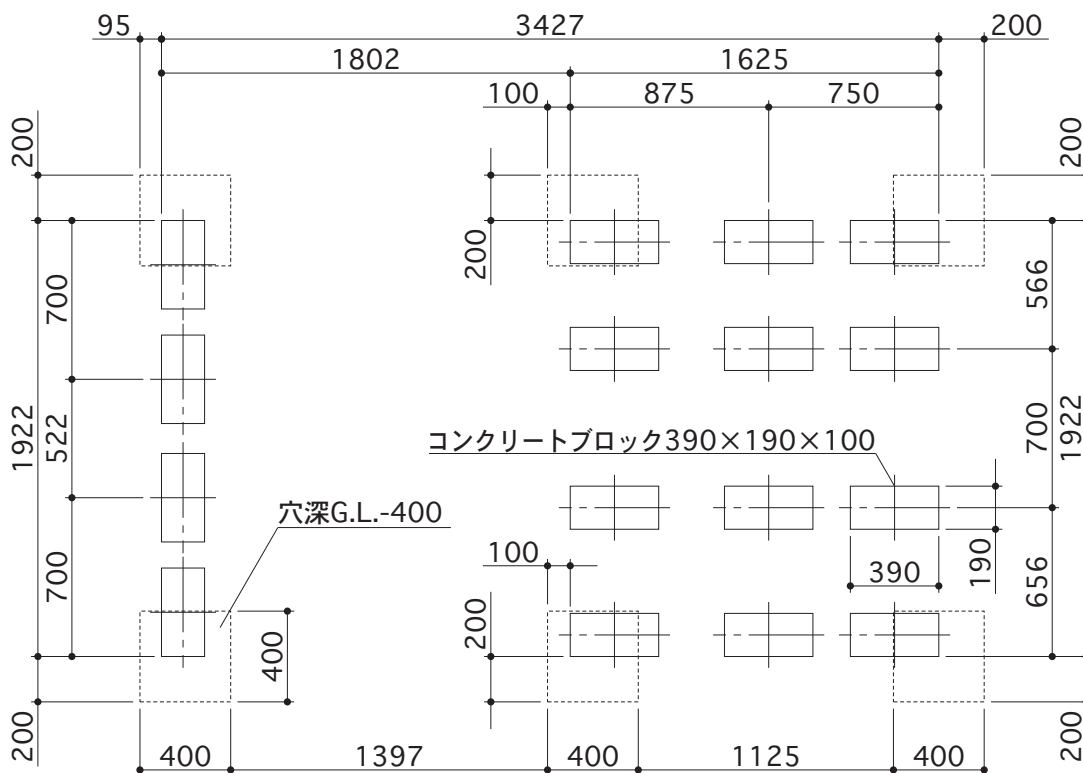

出入口側

