

# TP-31R26(左物置)

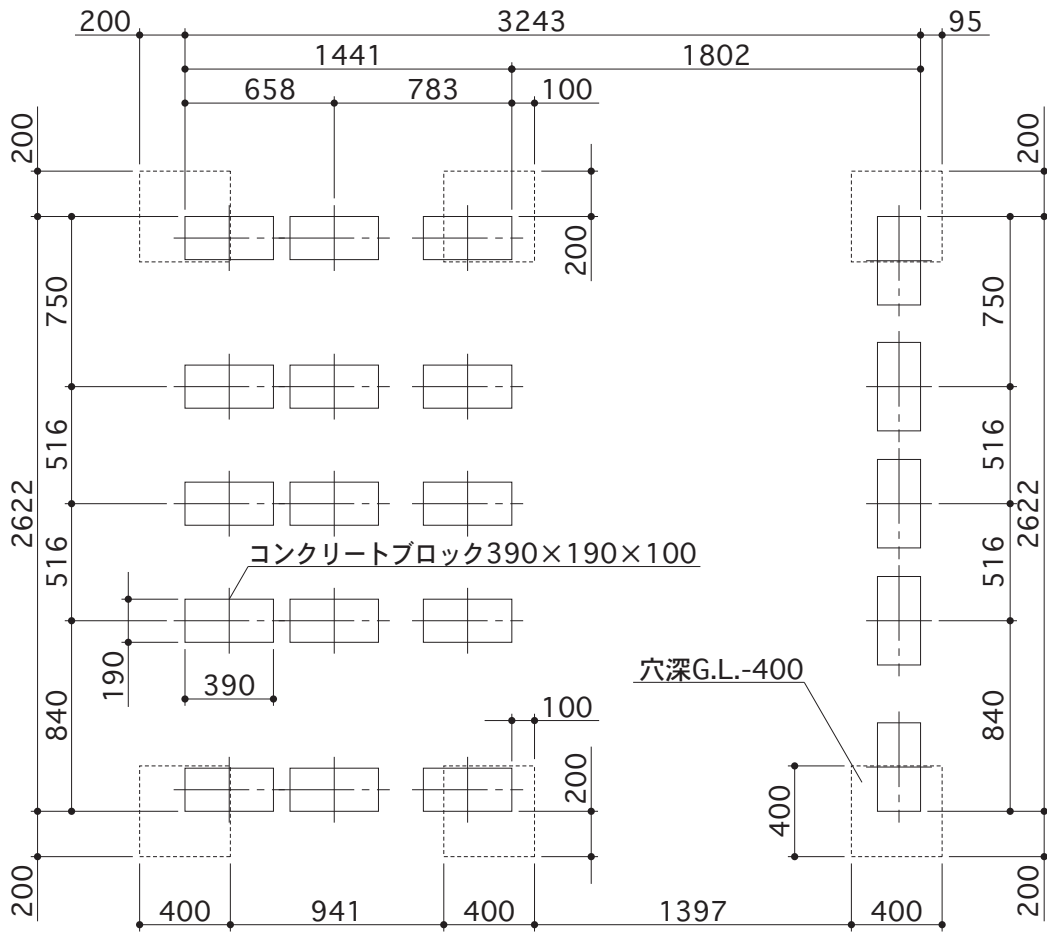

## 出入口側

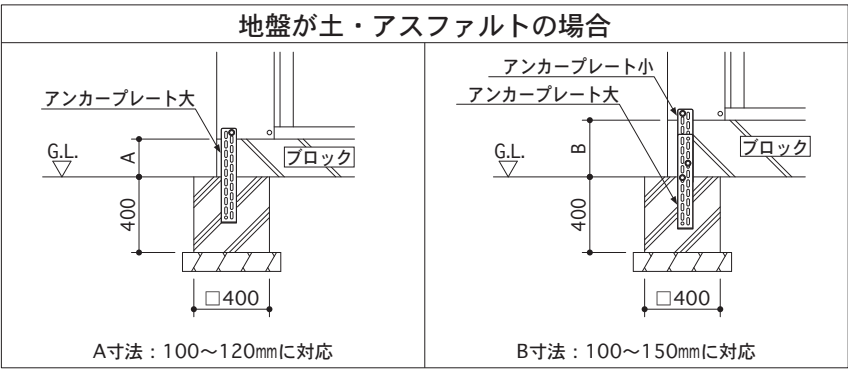
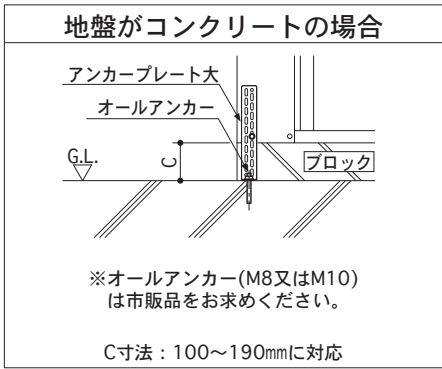

# TP-31R26(右物置)

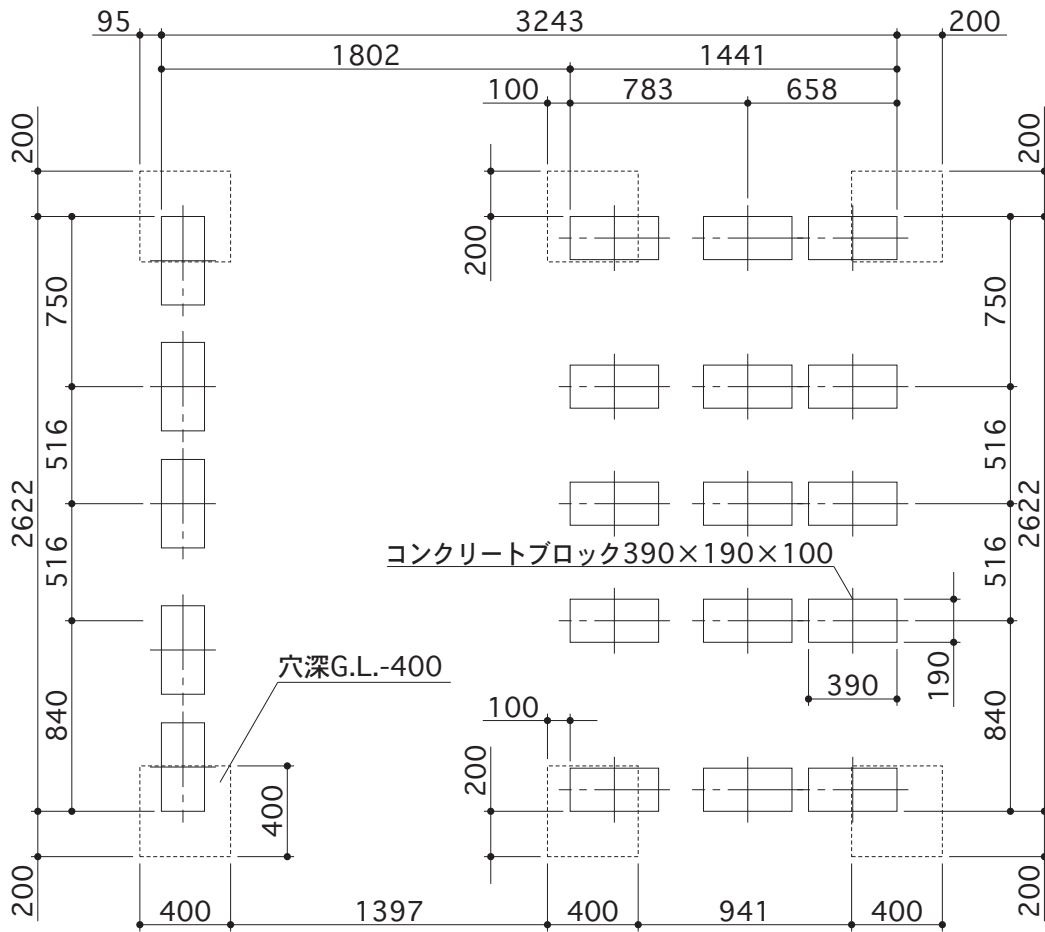

## 出入口側

