

TP-31R22(左物置)

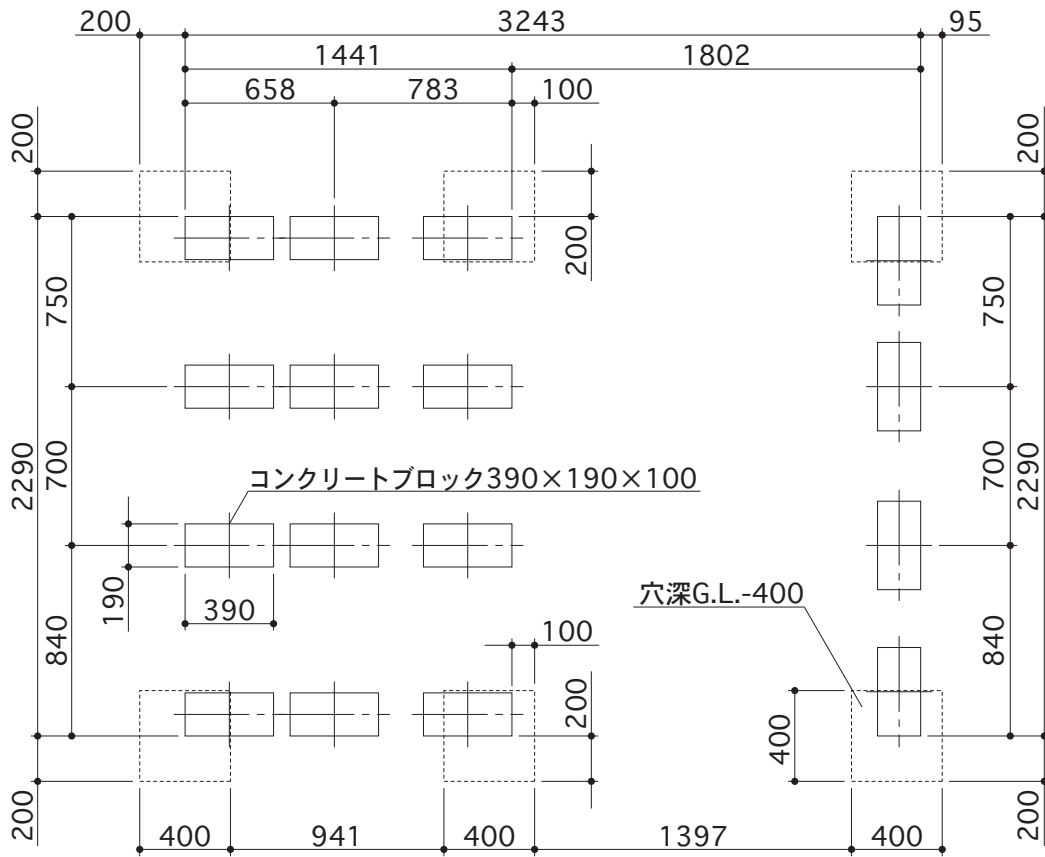

出入口側

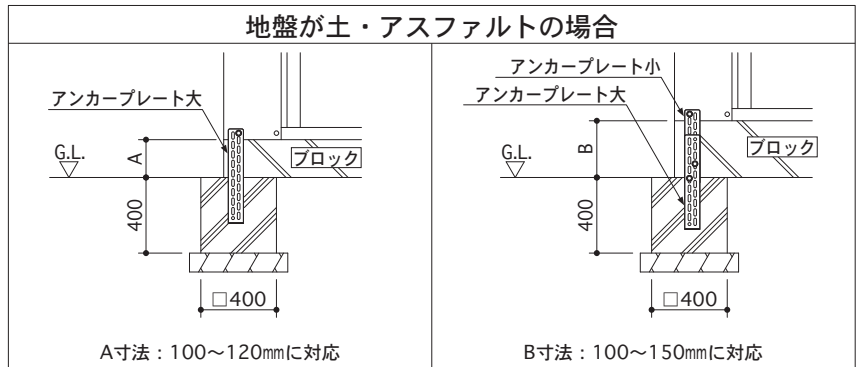
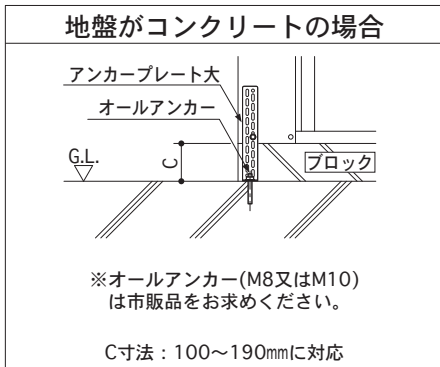

TP-31R22(右物置)

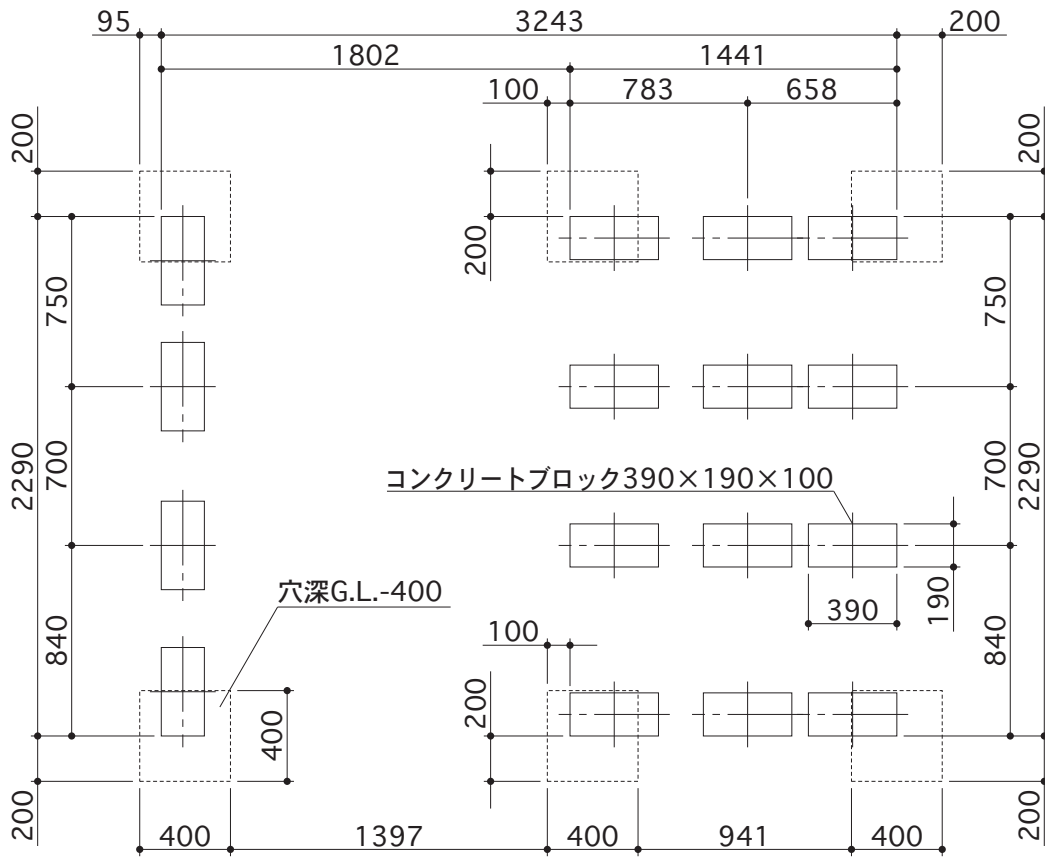

出入口側

