

# TP-2822(左物置)

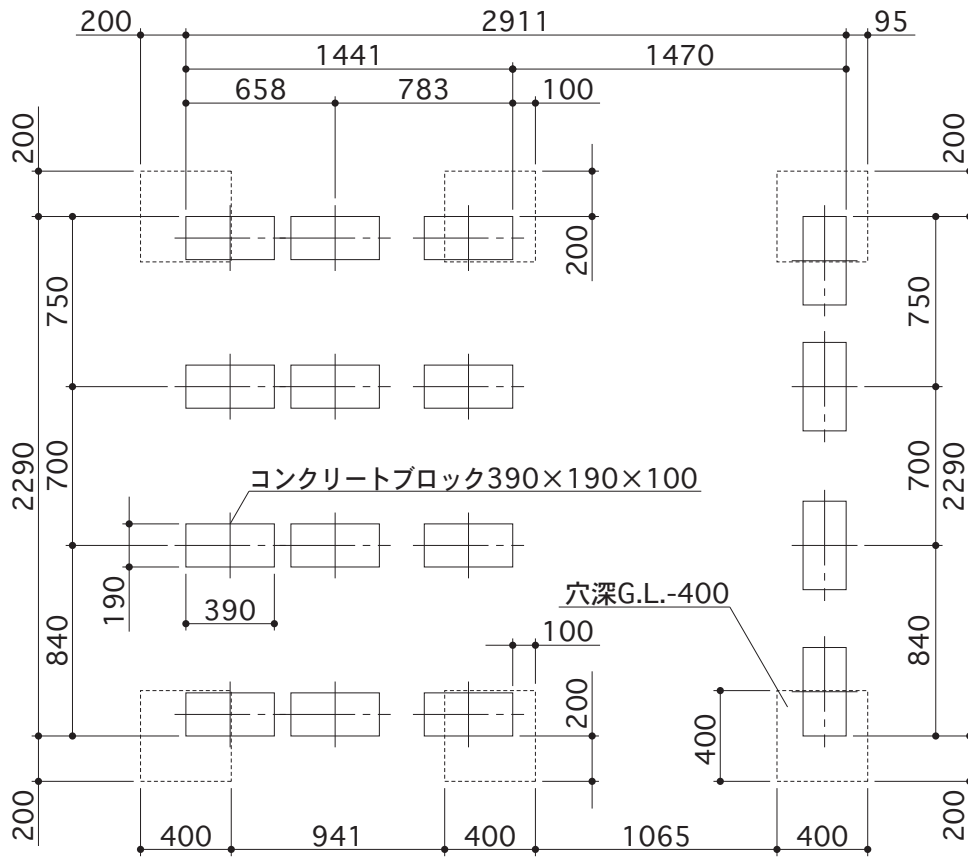

## 出入口側

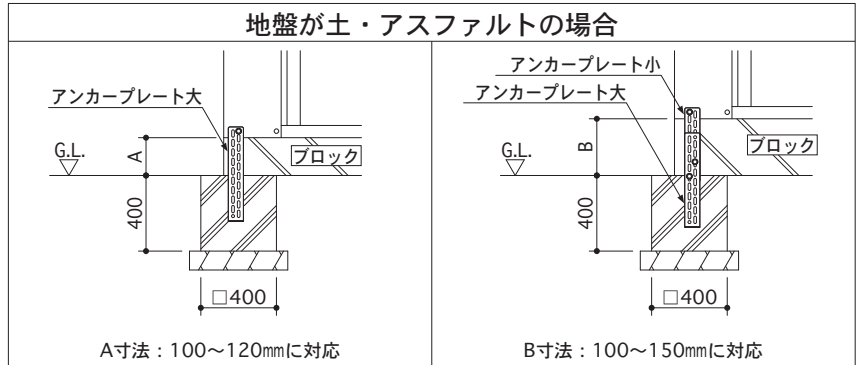
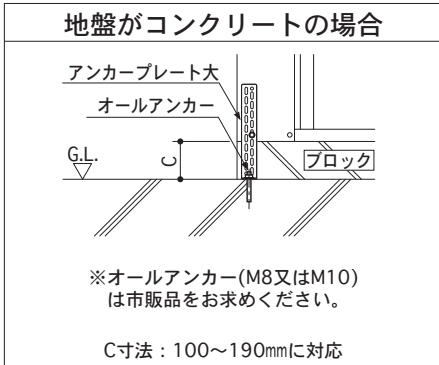

# TP-2822(右物置)

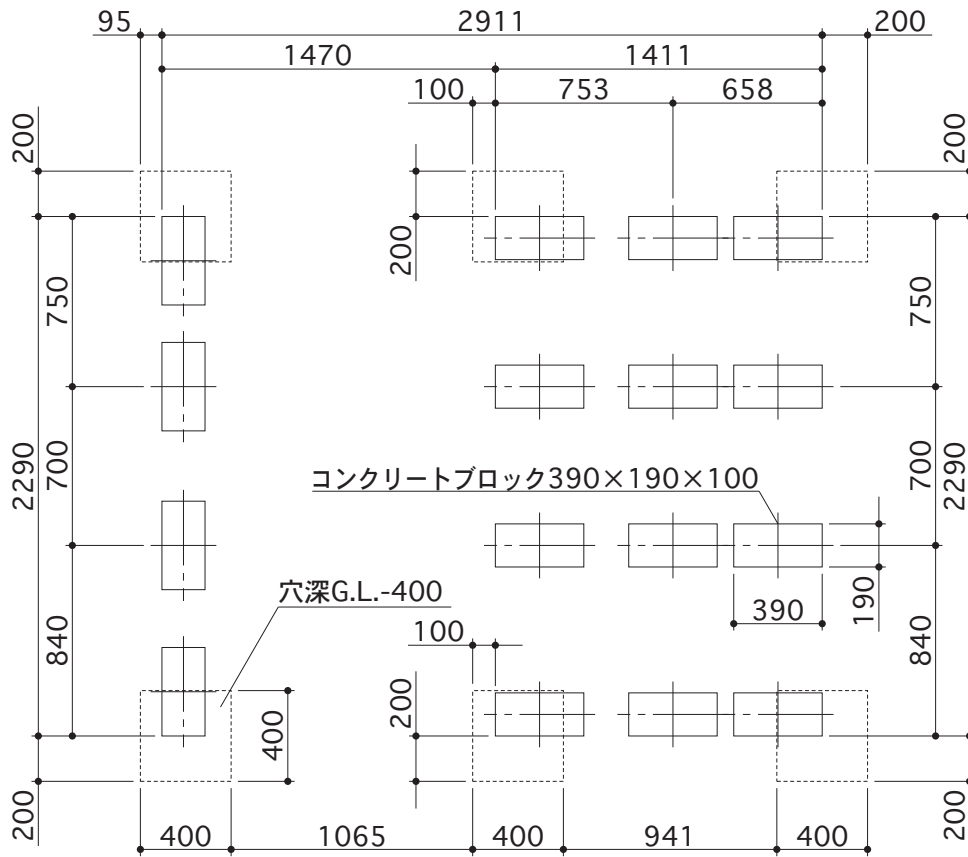

## 出入口側

