

# TP-3719(左物置)

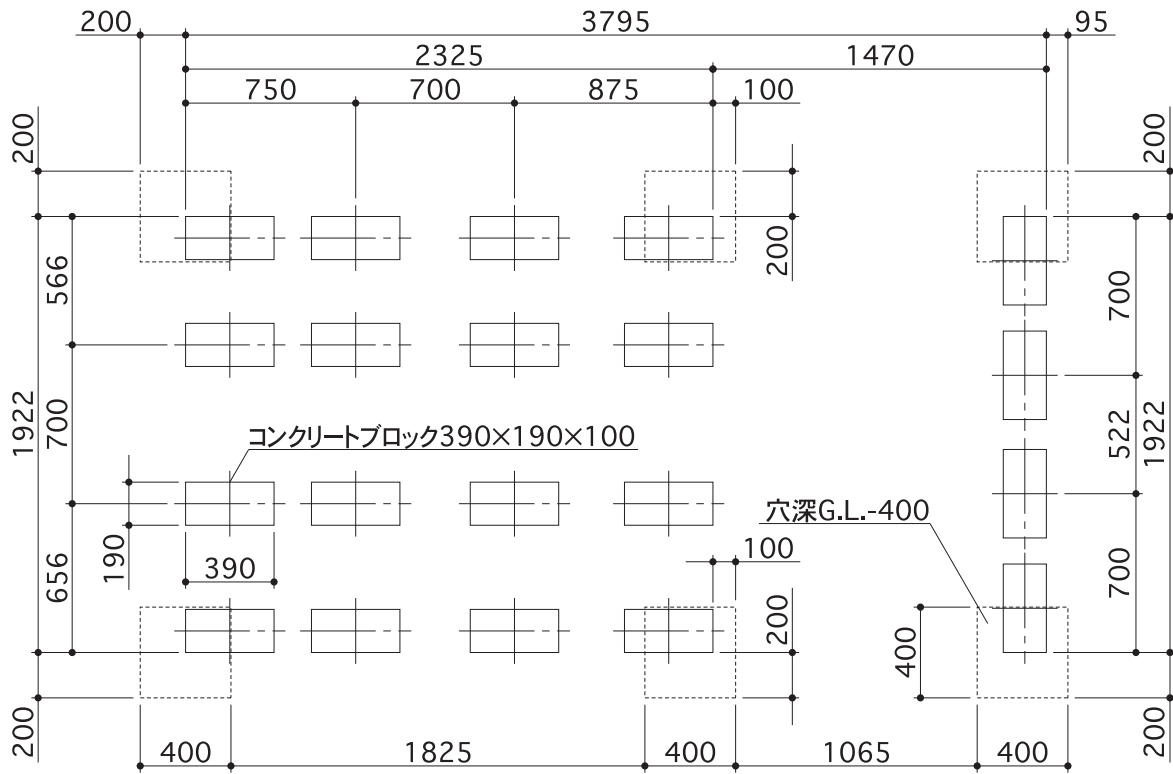

出入口側

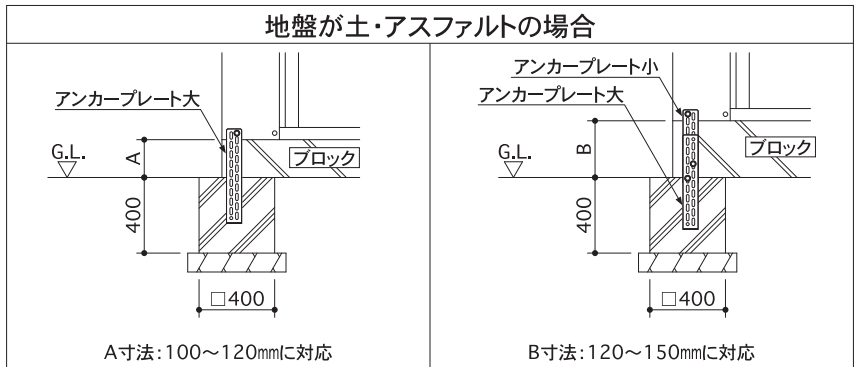
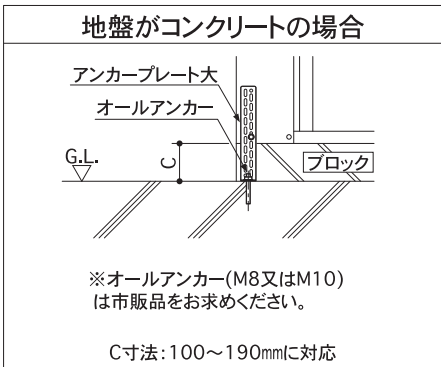

# TP-3719(右物置)

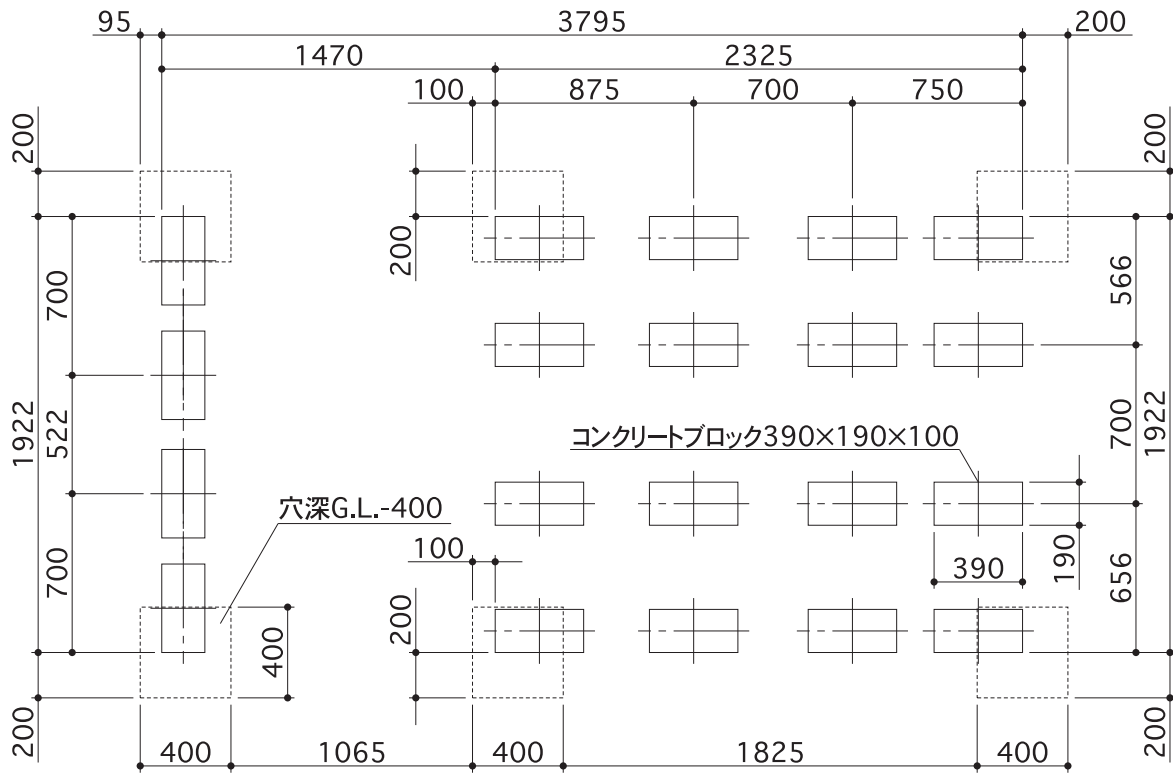

出入口側

