

TP-37R19(左物置)

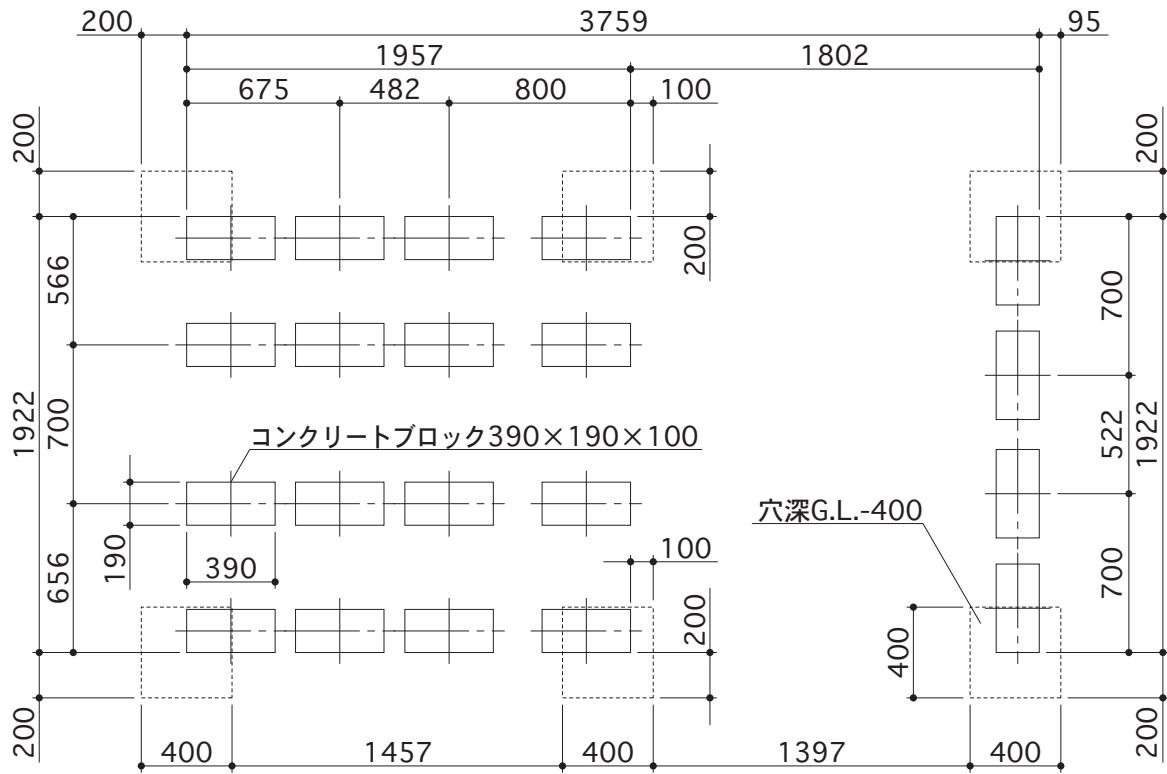

出入口側

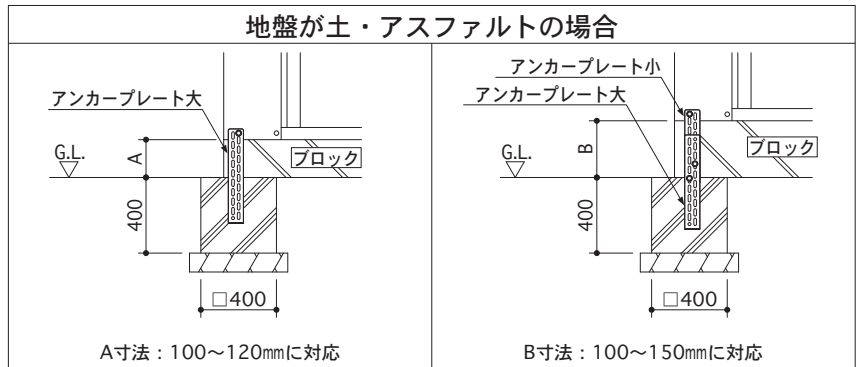
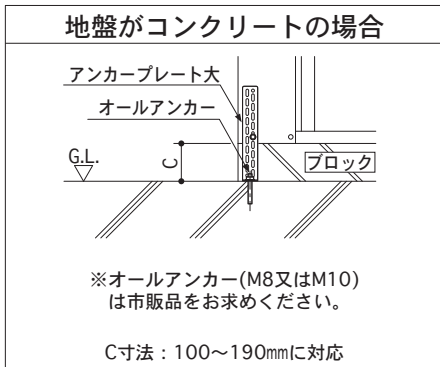

TP-37R19(右物置)

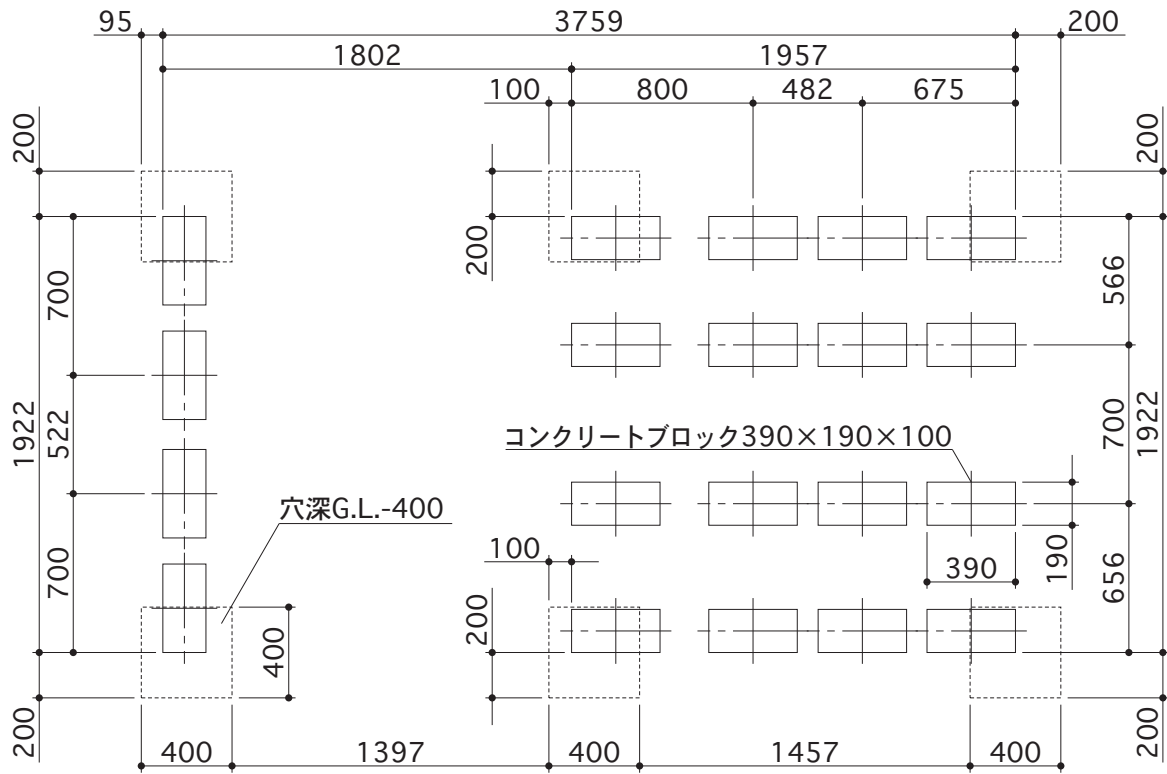

出入口側

