

# TP-3726(左物置)

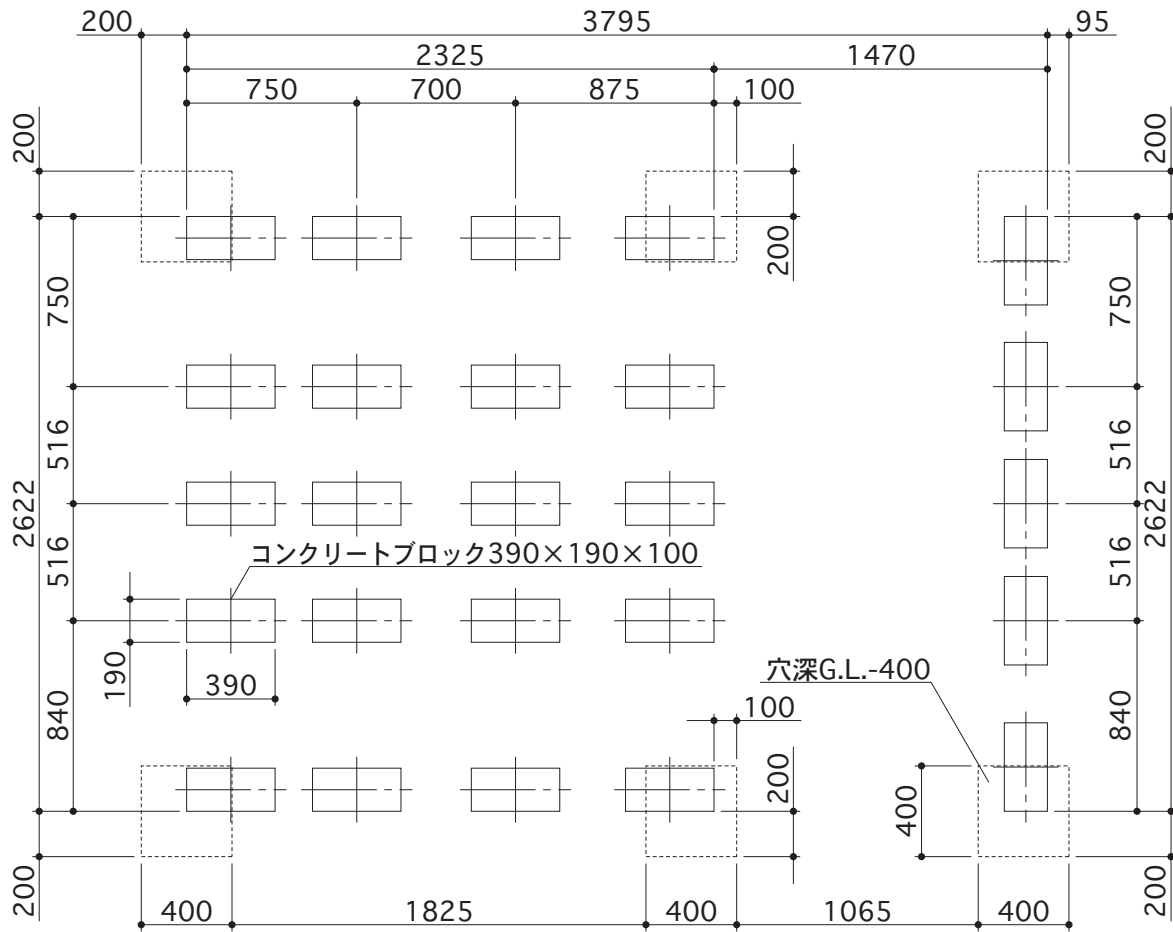

## 出入口側

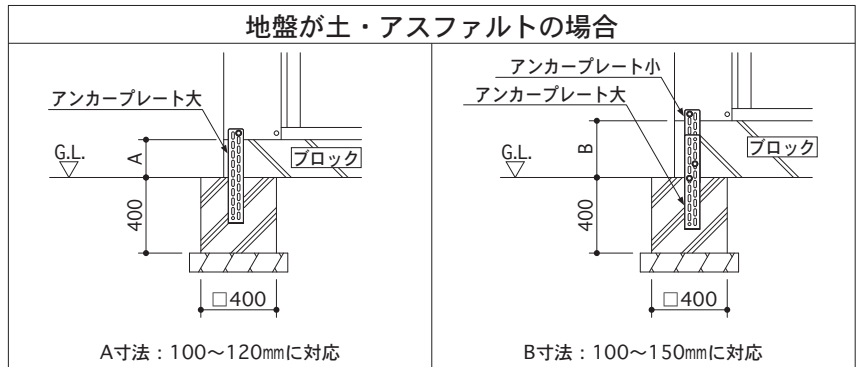
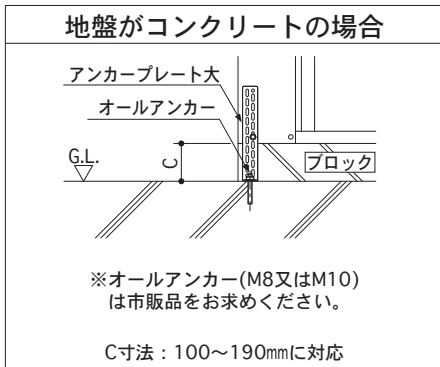

# TP-3726(右物置)

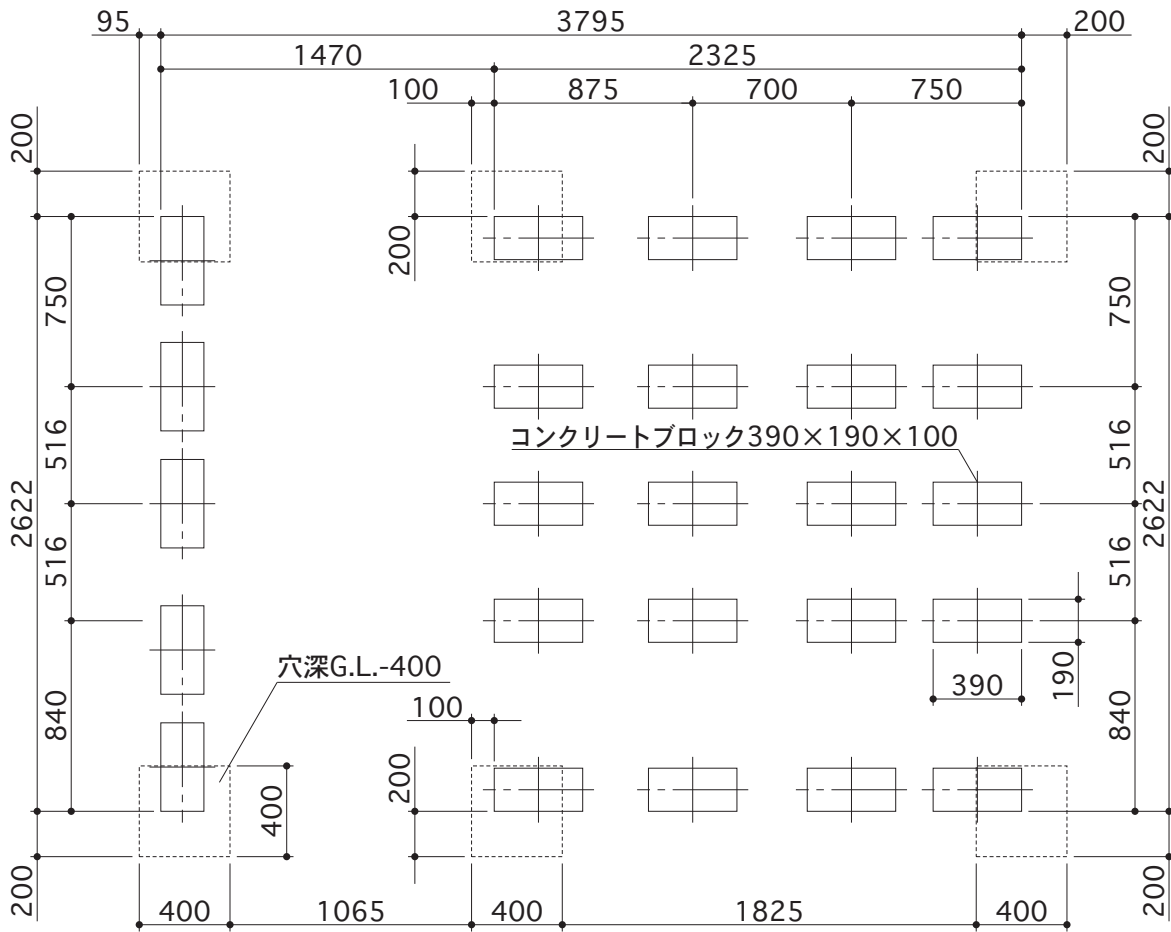

## 出入口側

