

TP-2822(左物置)

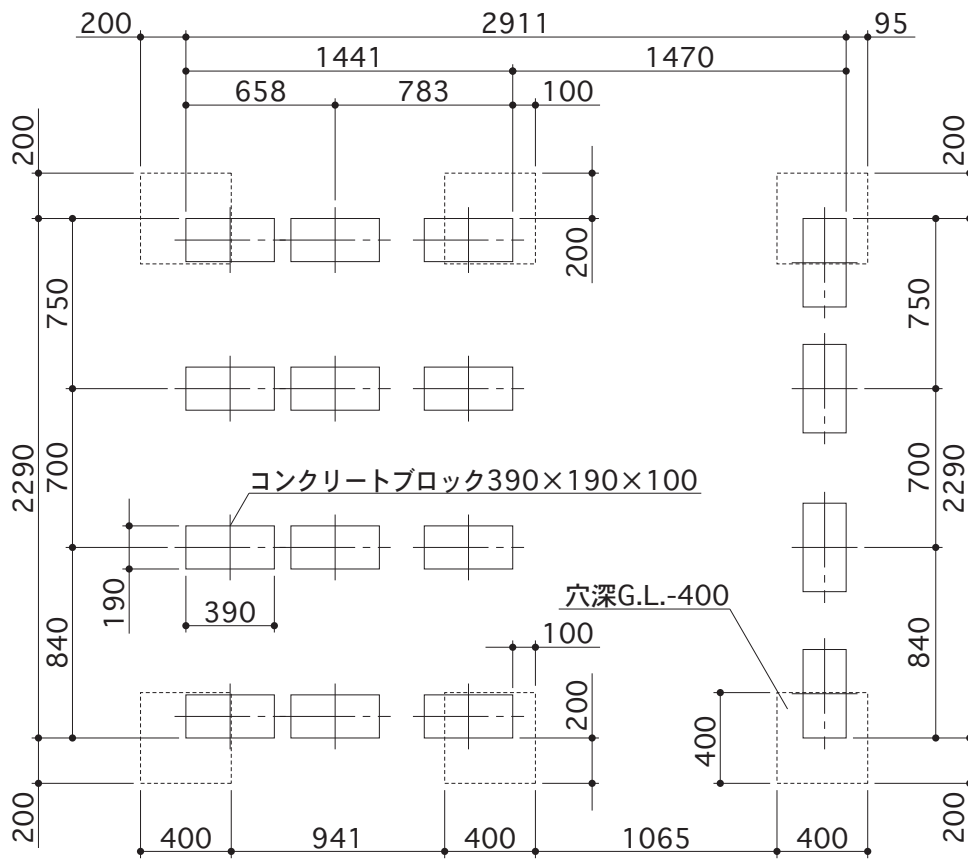

出入口側

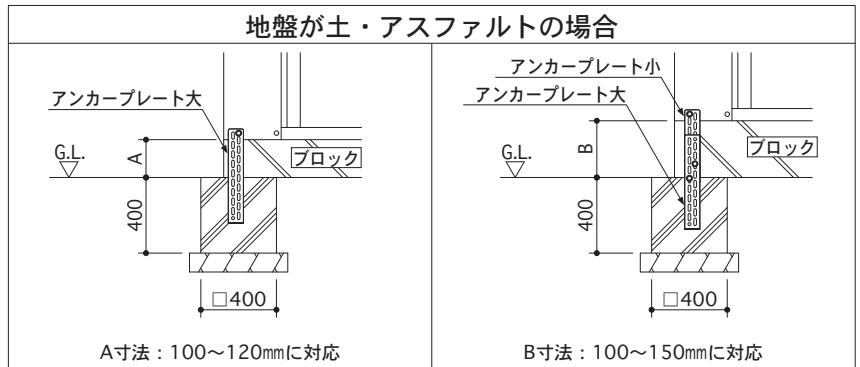
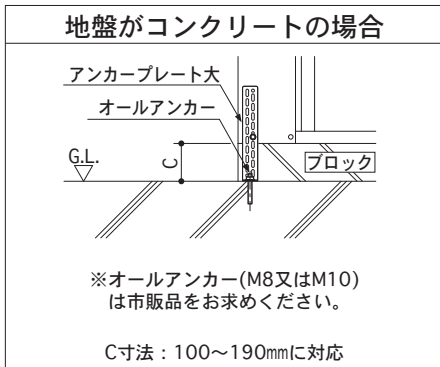

TP-2822(右物置)

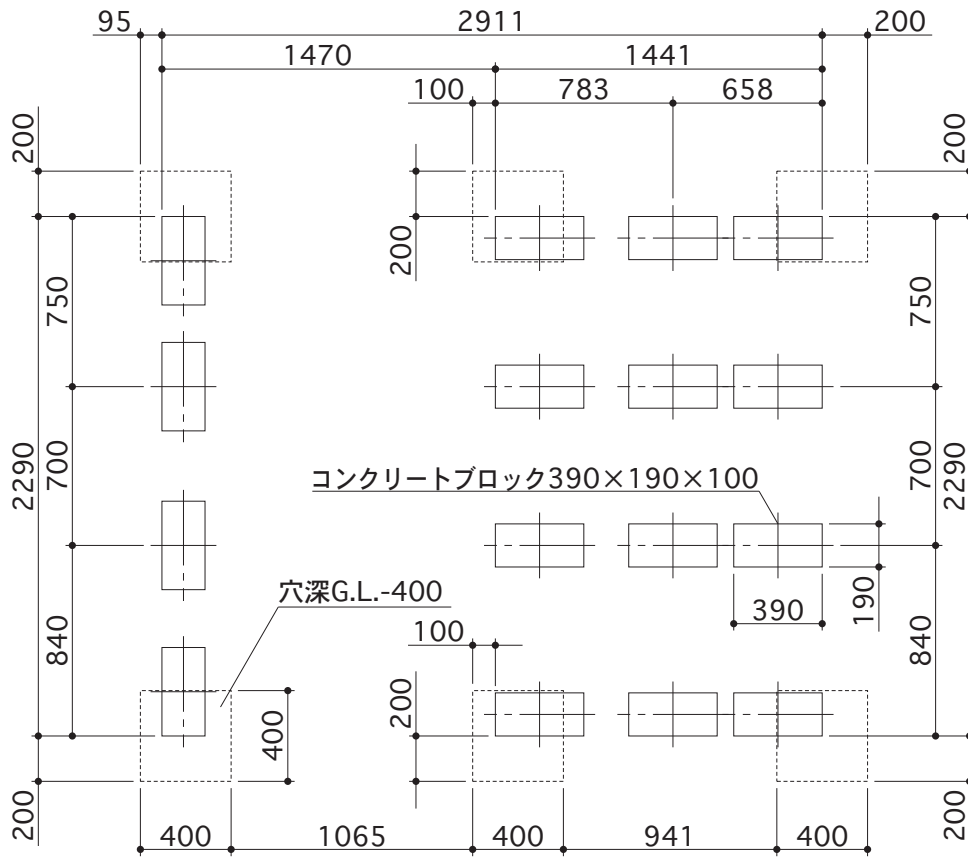

出入口側

