

TP-2819(左物置)

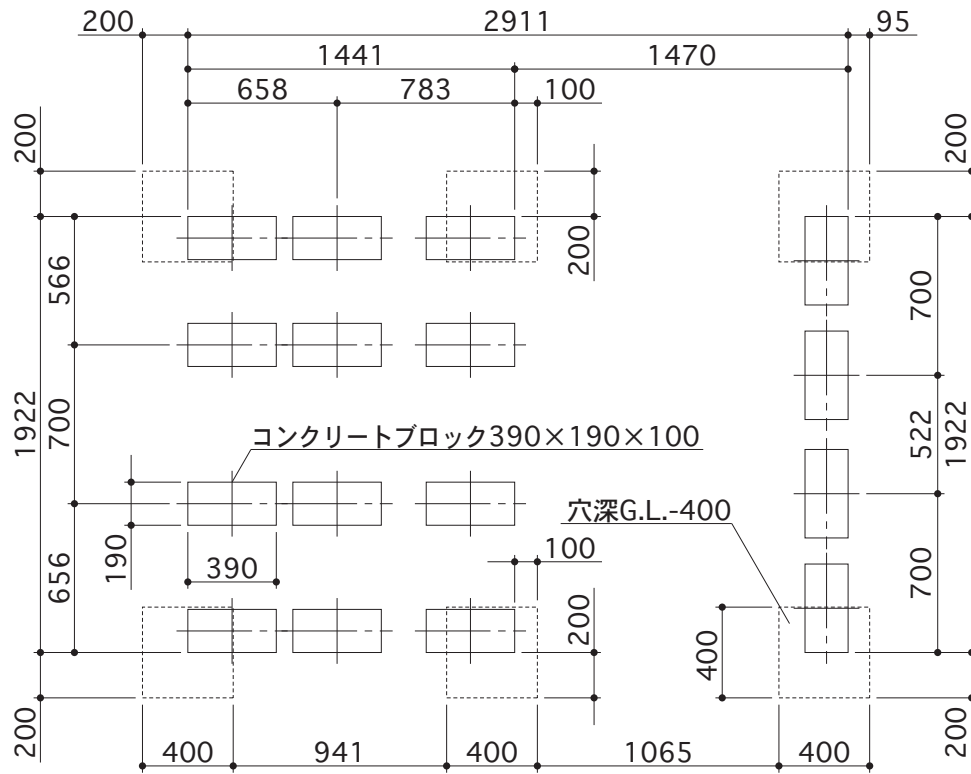

出入口側

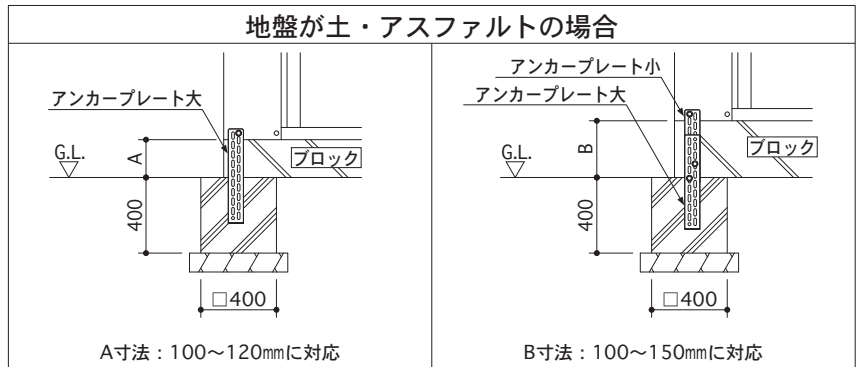
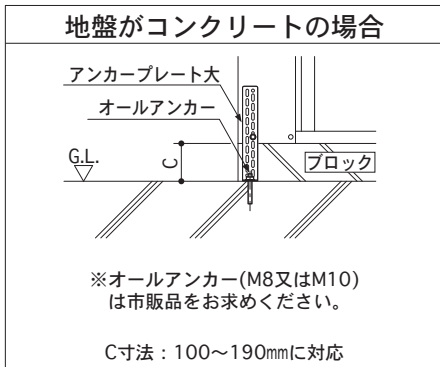

TP-2819(右物置)

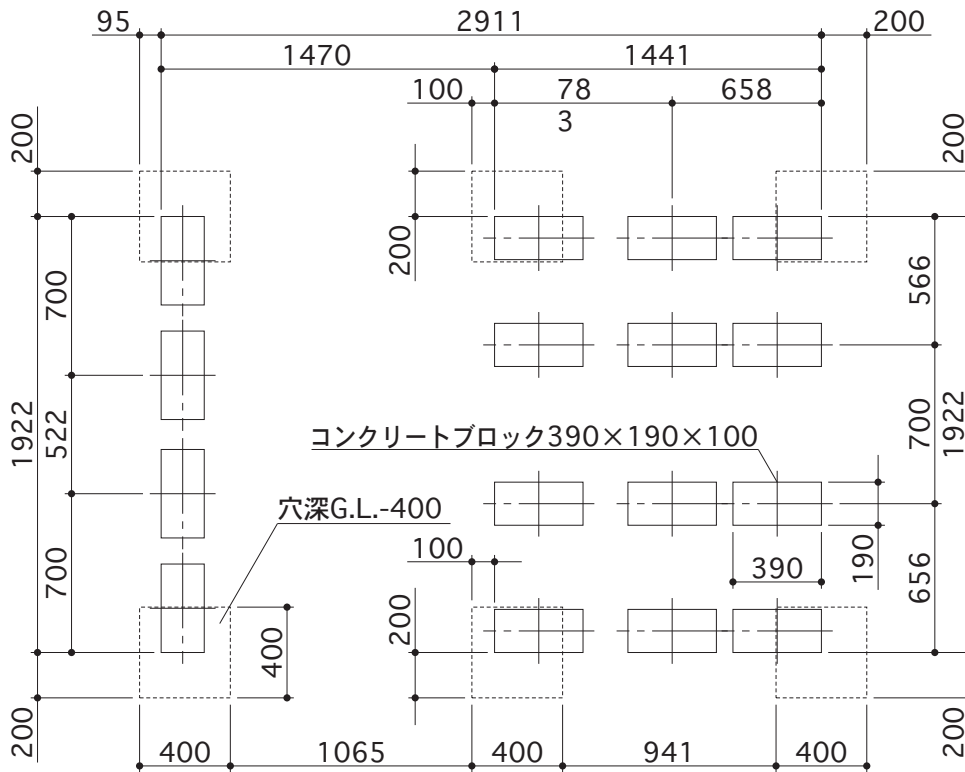

出入口側

