

TP-2815(左物置)

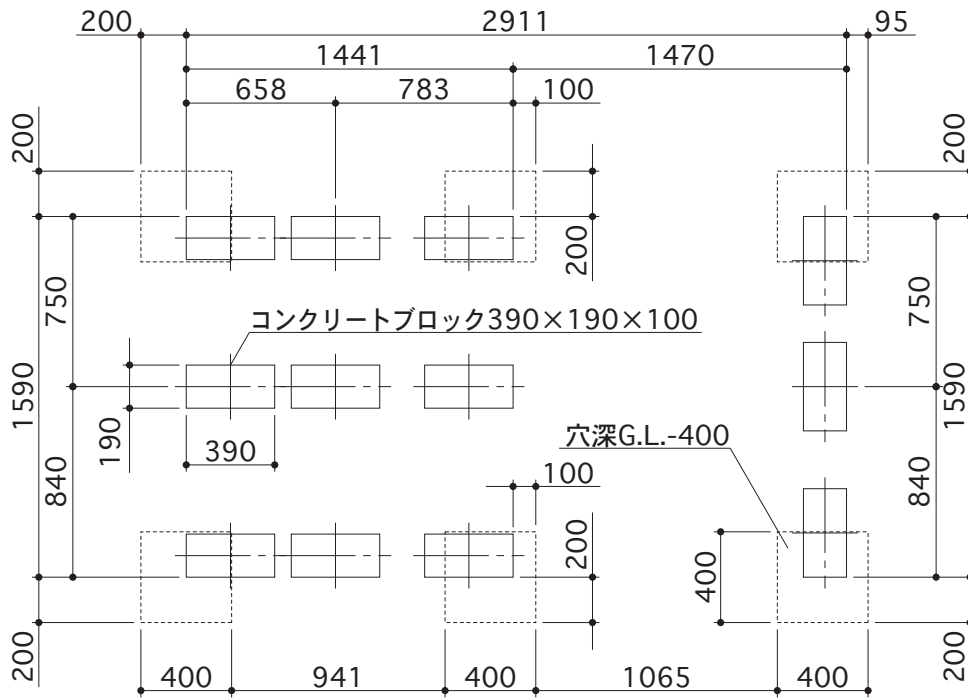

出入口側

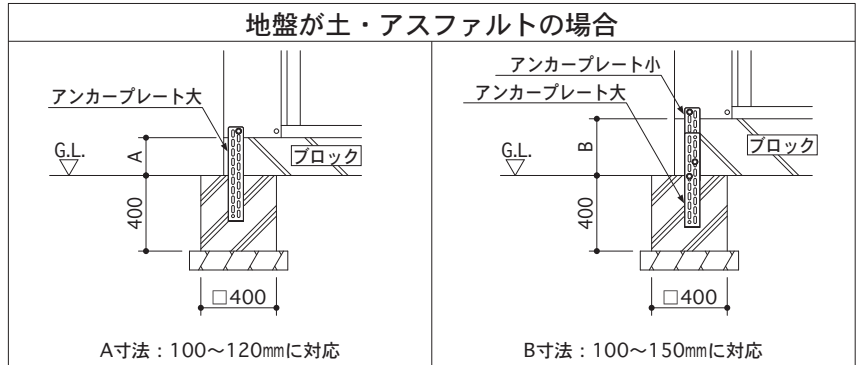
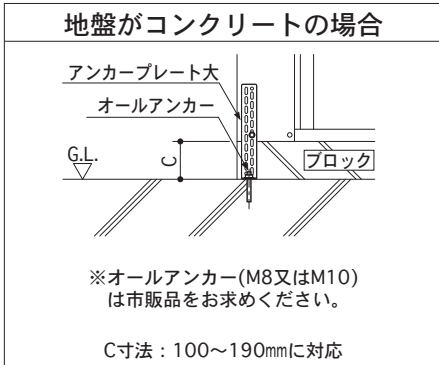

TP-2815(右物置)

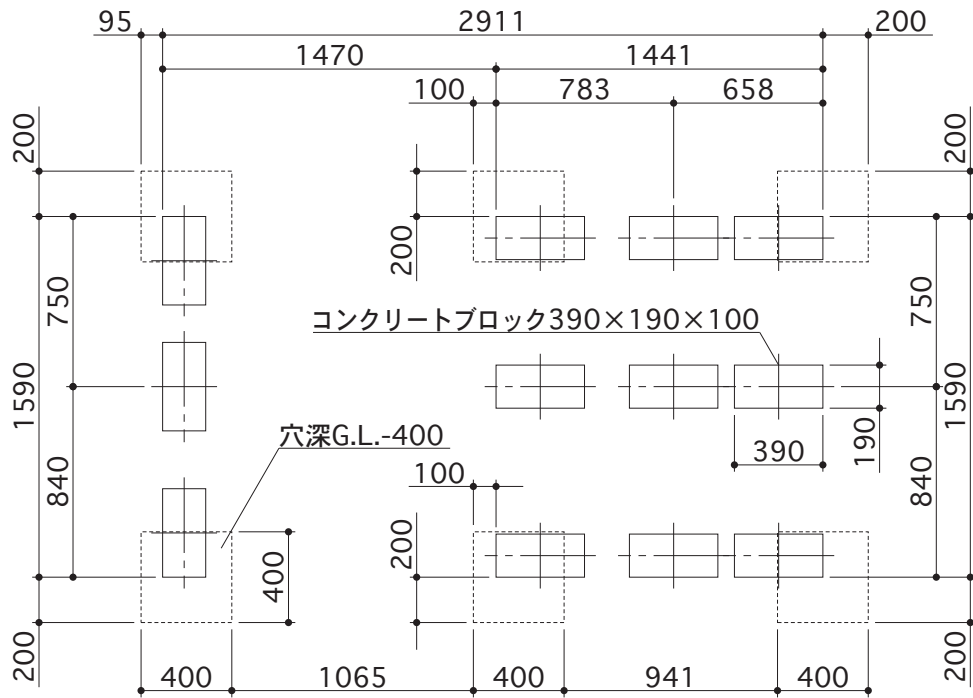

出入口側

