

# ND-5826

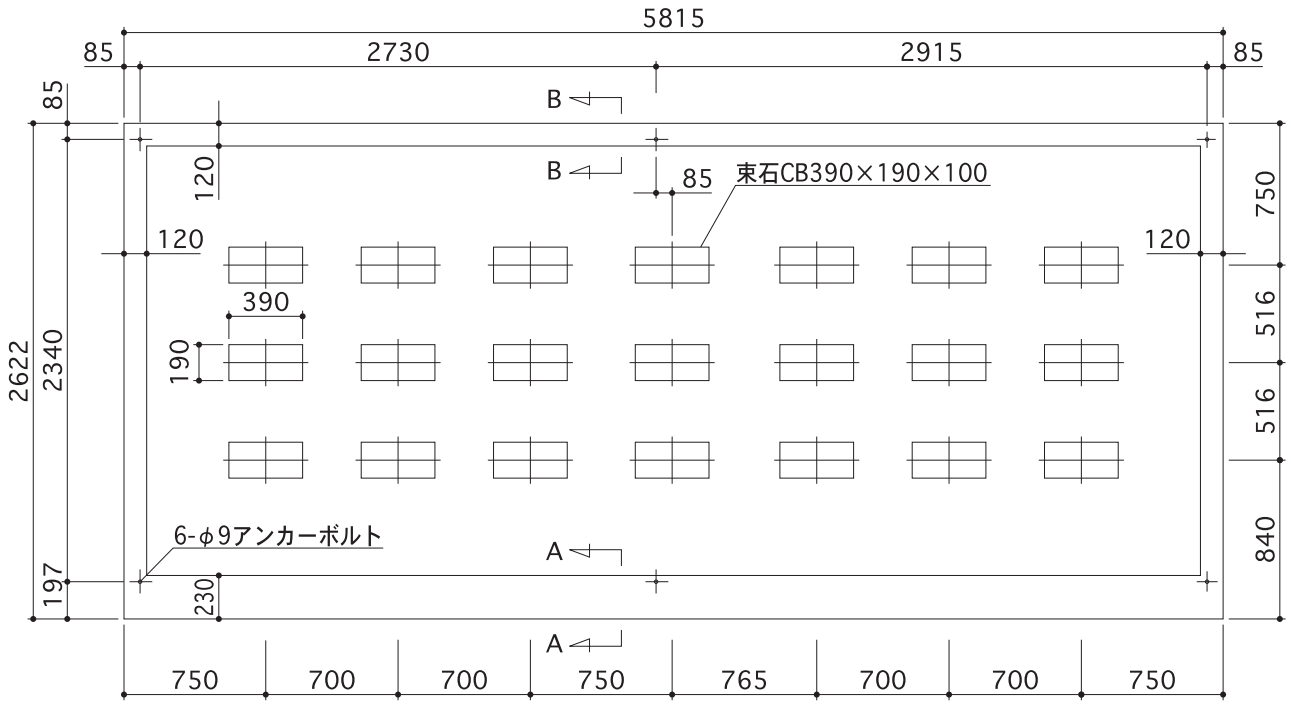

## 出入口側

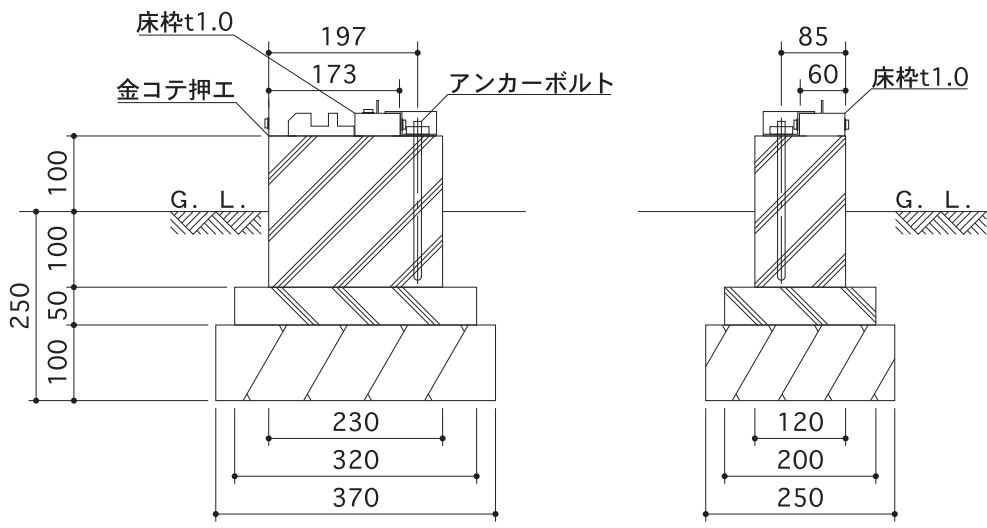

A-A断面図

B-B断面図