

# ND-5022

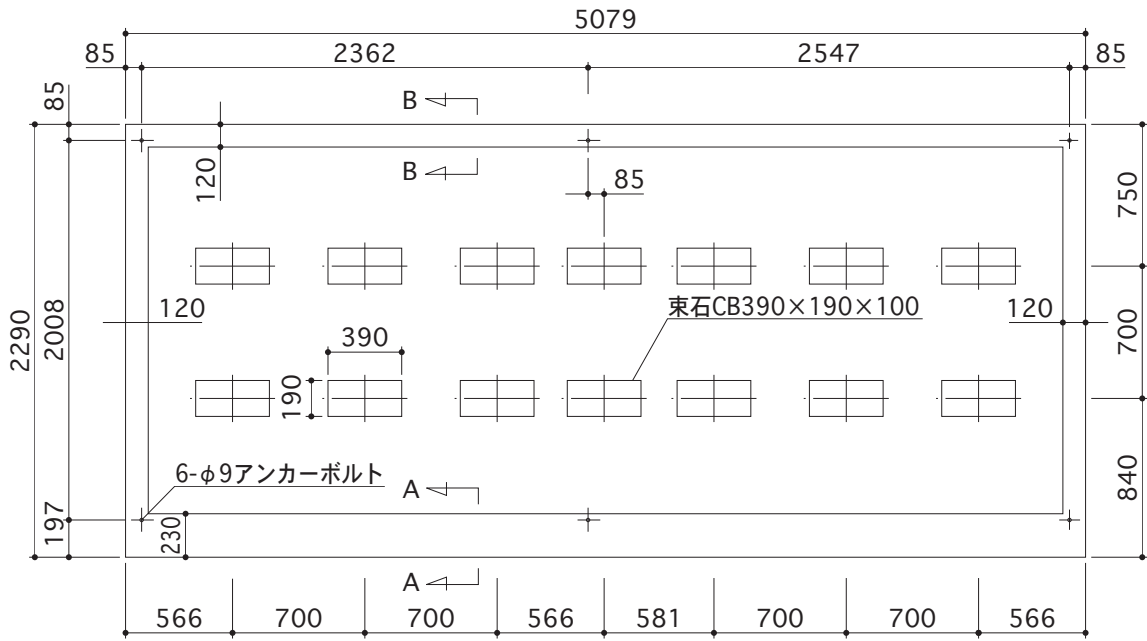

出入口側

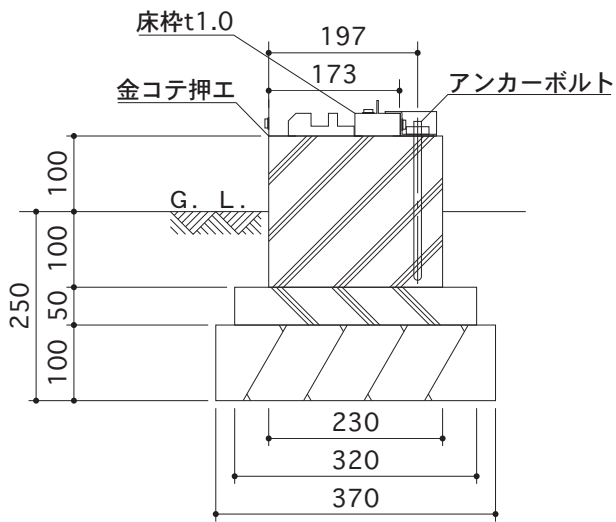

A-A断面図

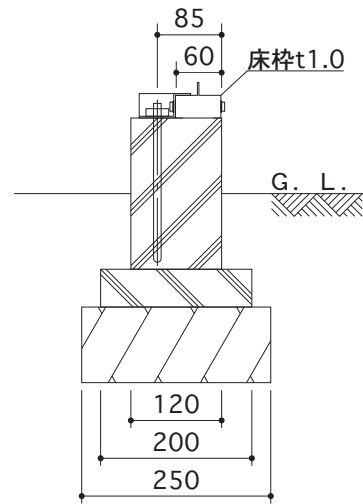

B-B断面図